

ACT 36 FARM FEED REGISTRATION WORKSHOP

THURSDAY, 26 MARCH 2026
IRENE COUNTRY CLUB, CENTURION

Supporting Documentation Required for
Farm Feed Registration Applications

Mrs. Sonto Mlambo, Technical Advisor
DoA - Act 36 of 1947



What to include in a **Farm Feed** Registration Application

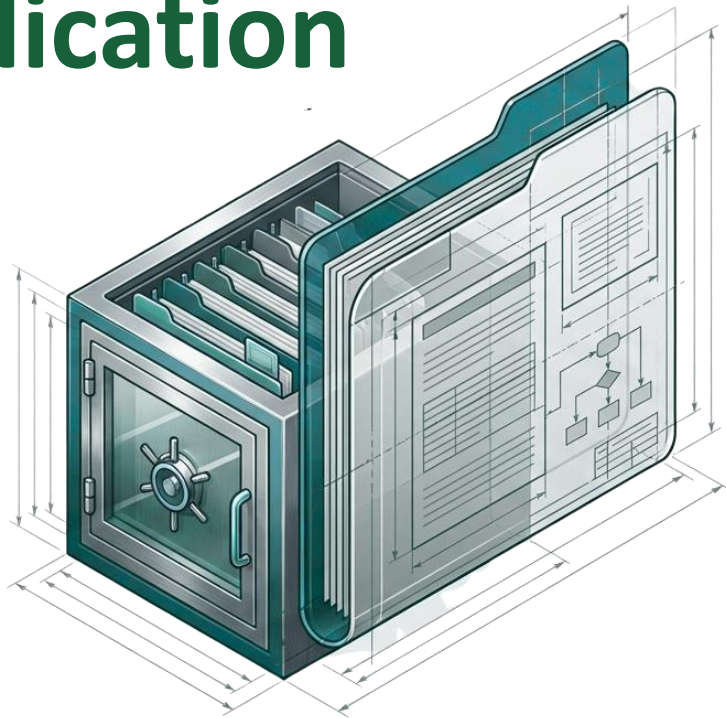

agriculture

Department:
Agriculture
REPUBLIC OF SOUTH AFRICA

The 5 Pillars of a Compliant Dossier

The 5 Pillars of a Compliant Dossier

Every document required by the Registrar under Act 36 of 1947 maps directly to one of these five structural pillars. Build the foundation first, then prove the science and safety.

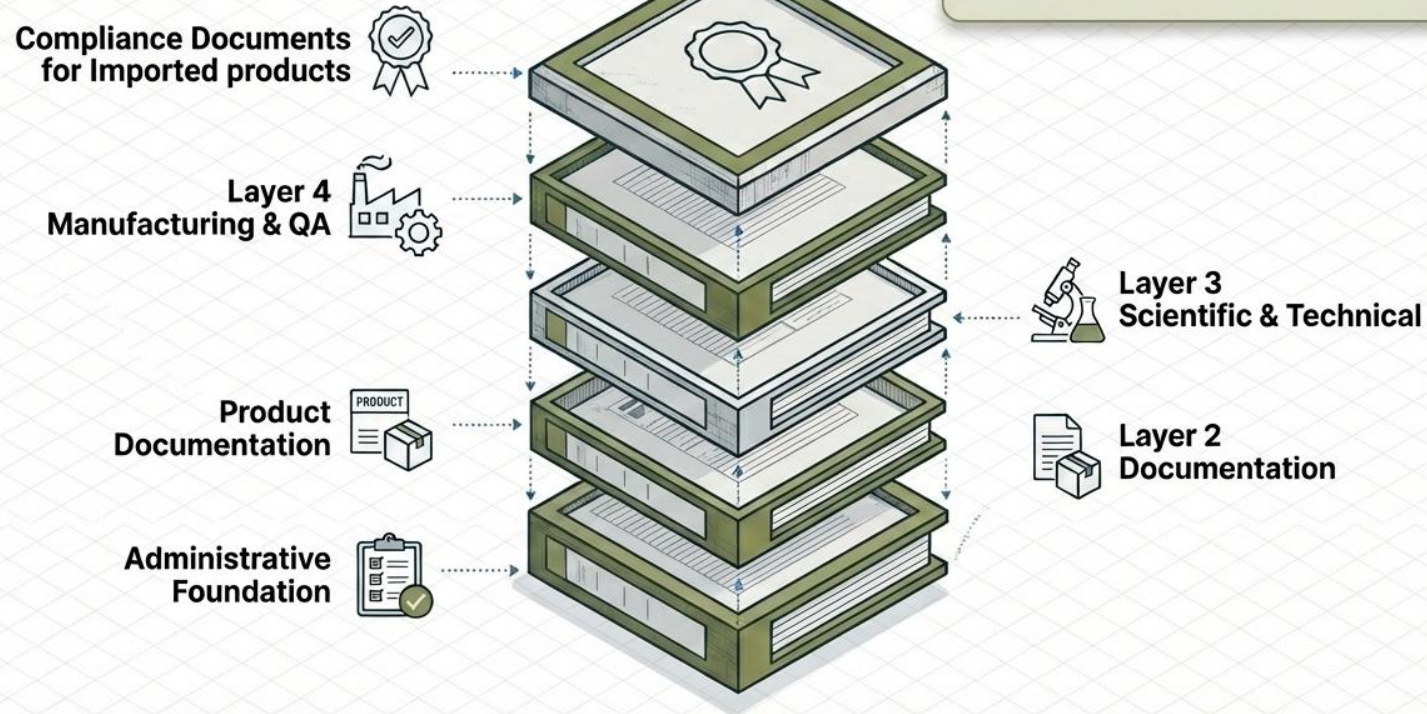

agriculture

Department:
Agriculture
REPUBLIC OF SOUTH AFRICA



Pillar 1: The Administrative Foundation

These universal documents initiate the registration request and provide the required information to the Registrar for both Feed Additives and Premixtures.

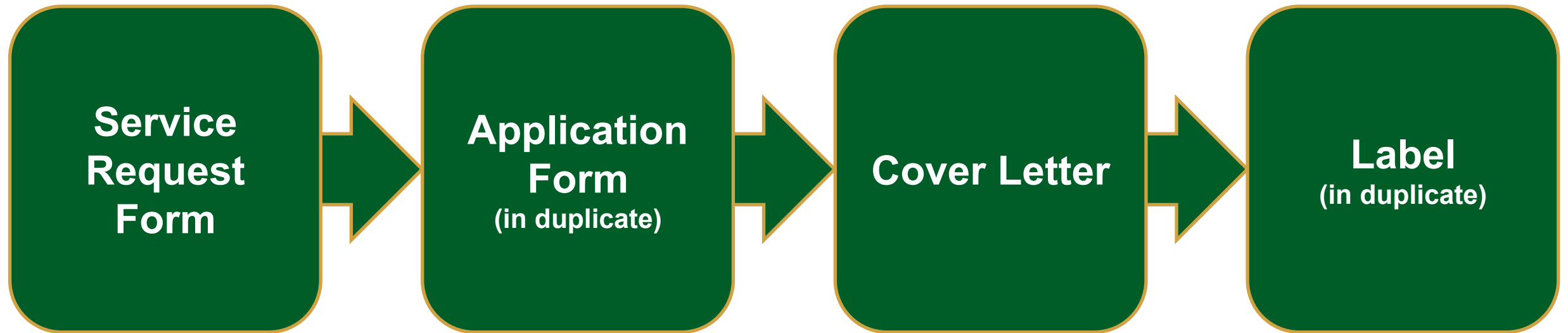

agriculture

Department:
Agriculture
REPUBLIC OF SOUTH AFRICA



The Divergence Matrix: Feed Additives vs Premixtures

	Feed Additives	Premixtures
Administrative Foundation	✓	✓
Product Documentation	Standard Product COA	Formulation Report + Constituent COAs
Scientific & Technical	Efficacy/Tox Data & Analytical Methods required	N/A
Manufacturing & QA	✓	✓
Regulatory Sign-off	Accepts signatures from Vets/Pharmacists (for specific pet products)	Defaults strictly to SACNASP-registered animal scientists



agriculture

Department:
Agriculture
REPUBLIC OF SOUTH AFRICA



Non-Negotiable Technical Evidence

The Certificate of Analysis (COA)

Rule: Must be authenticated, strictly less than one year old, and performed by an accredited laboratory. Must match formulation guarantees.

Formulator Declaration

Rule: Must confirm professional oversight. Strictly requires signature from a SACNASP-registered animal scientist, registered veterinarian, or registered pharmacist.

Claims Rules

Rule: Must be objective and verifiable.

Absolute Red Line: Medicinal claims are strictly prohibited for feed additives.



agriculture

Department:
Agriculture
REPUBLIC OF SOUTH AFRICA



The Anatomy of a Compliant Product Label

Label Anatomy: Structuring the Visual Presentation

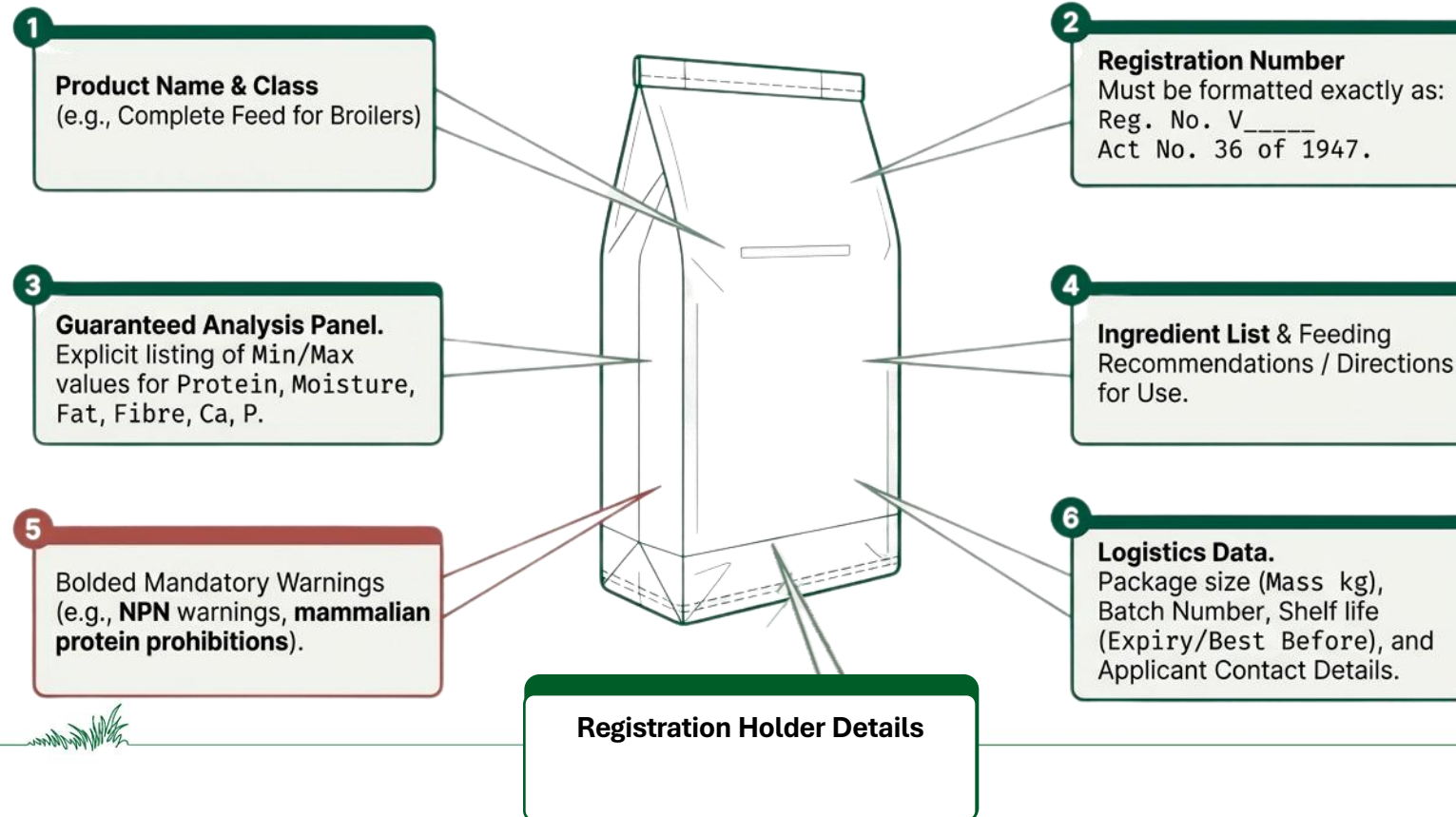

agriculture

Department:
Agriculture
REPUBLIC OF SOUTH AFRICA



Pillar 3: Scientific & Technical Documentation

This is the most demanding component of a **Feed Additive** dossier. It underpins the **safety, efficacy, and intended use** of products such as PhytoBoost.

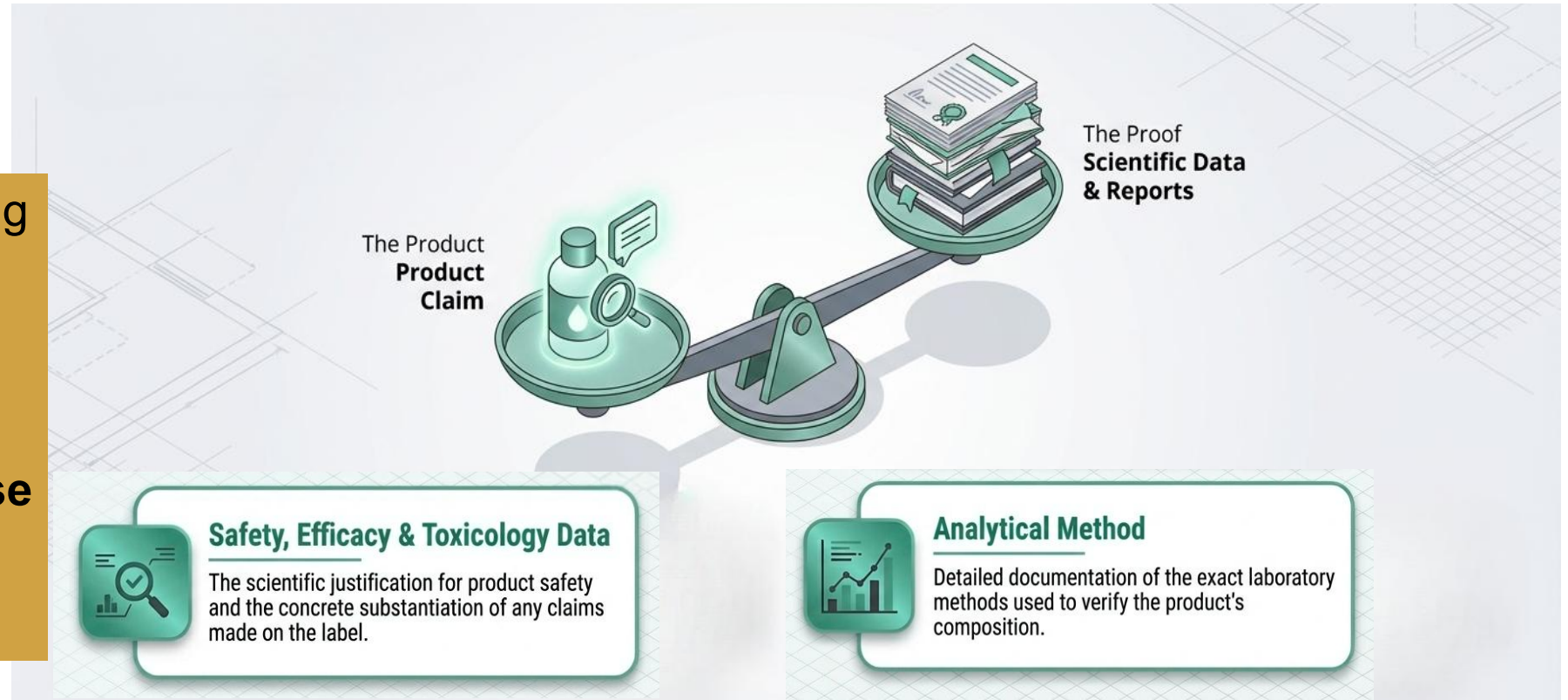

Key Insight: You cannot claim what you cannot scientifically substantiate and analytically measure.



agriculture

Department:
Agriculture
REPUBLIC OF SOUTH AFRICA



Pillar 4: Manufacturing & Quality Assurance Documentation

Demonstrating that the product - whether a feed additive or premixture - is produced under controlled conditions.

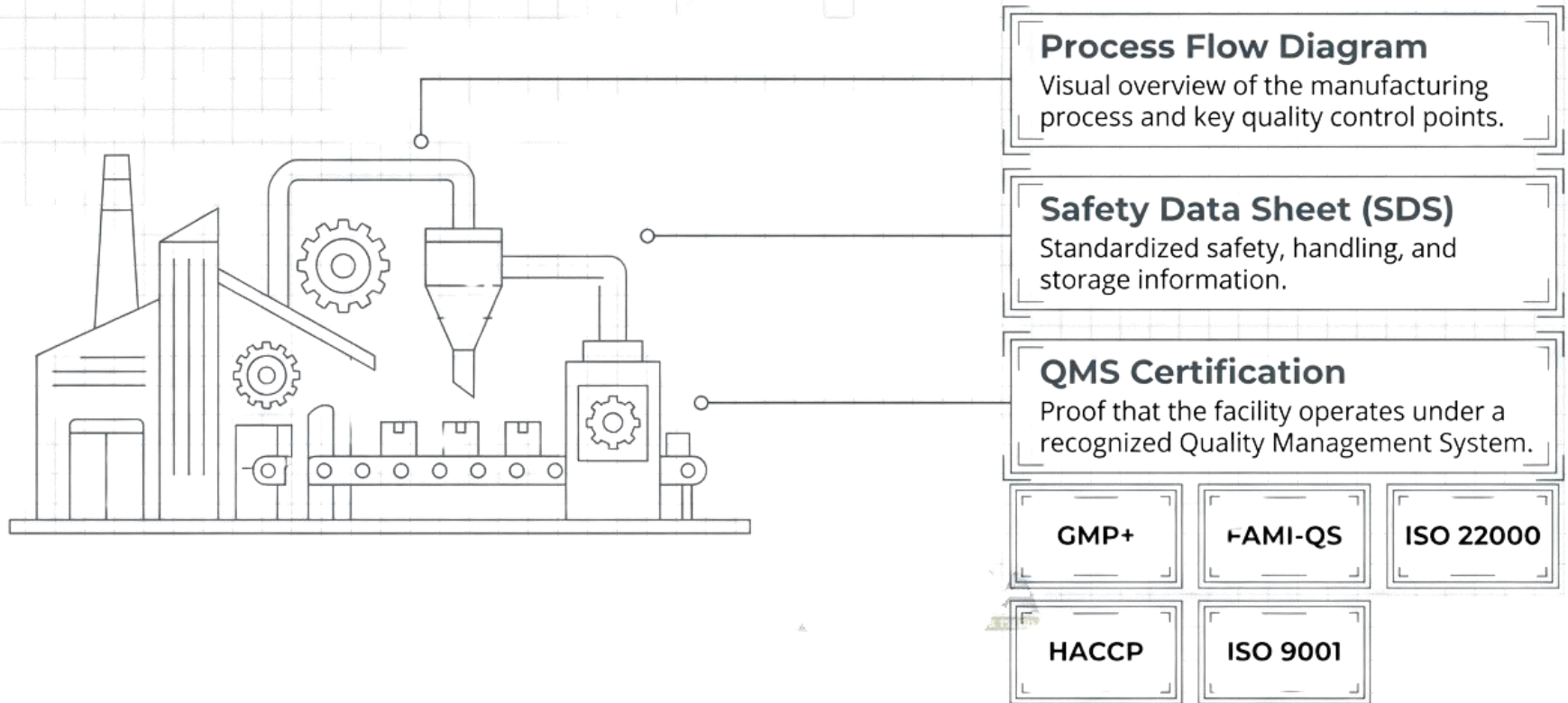

agriculture

Department:
Agriculture
REPUBLIC OF SOUTH AFRICA



Pillar 5: Compliance Documents For Imported Products

Jurisdictional Requirements

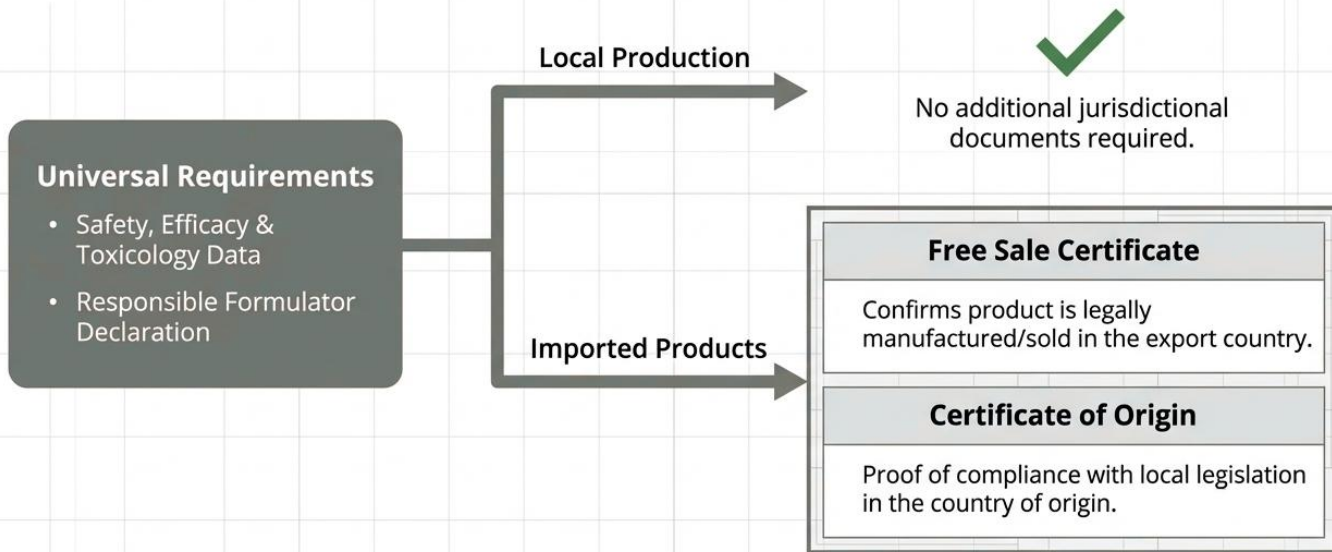

If the product is manufactured outside of South Africa, the dossier must **legally anchor it to its country of origin.**



agriculture

Department:
Agriculture
REPUBLIC OF SOUTH AFRICA



Physical Presentation

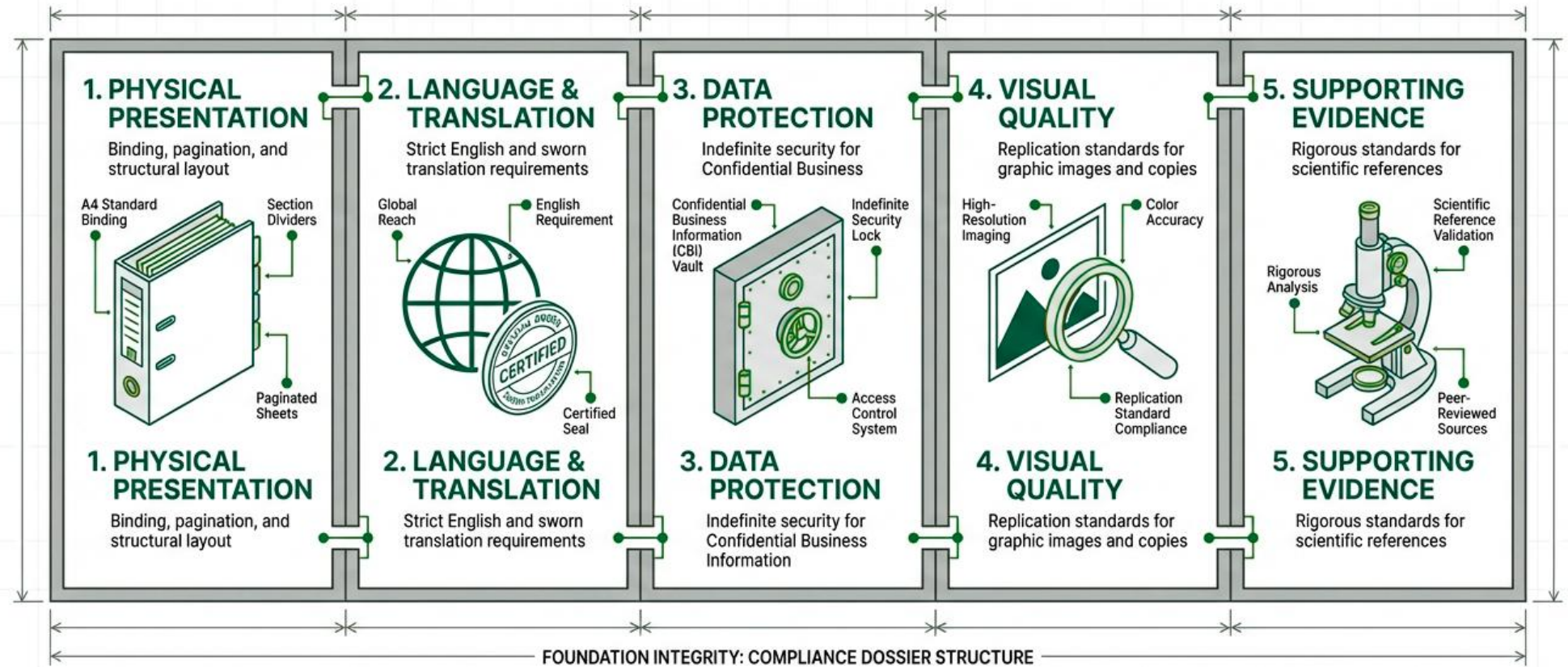

agriculture

Department:
Agriculture
REPUBLIC OF SOUTH AFRICA



Formatting the Physical Dossier

Sequential Numbering System

Volume 1: Pages 1.1, 1.2, 1.3...
Volume 2: Pages 2.1, 2.2, 2.3...

Reproduction Quality

Legible with adequate margins on both edges. Types applications preferred.

Graphic Standards

Original prints preferred. High-quality replication required for graphic images.

Confidentiality Layers

Securely locate commercially sensitive data (exact formulas, non-relevant impurities) behind distinct tabs).

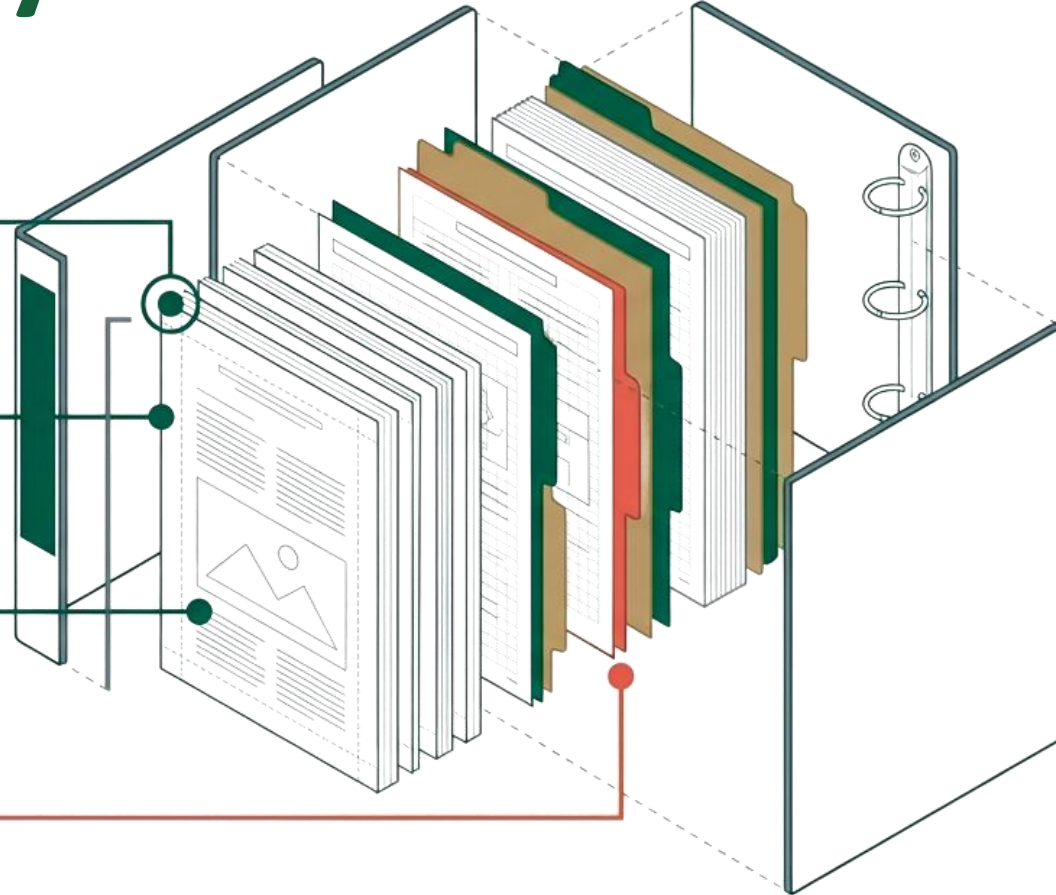

agriculture

Department:
Agriculture
REPUBLIC OF SOUTH AFRICA



Physical Architecture & Binding

All documents must be printed legibly on A4 paper and presented in a systematic order.

LEVER ARCH FILES

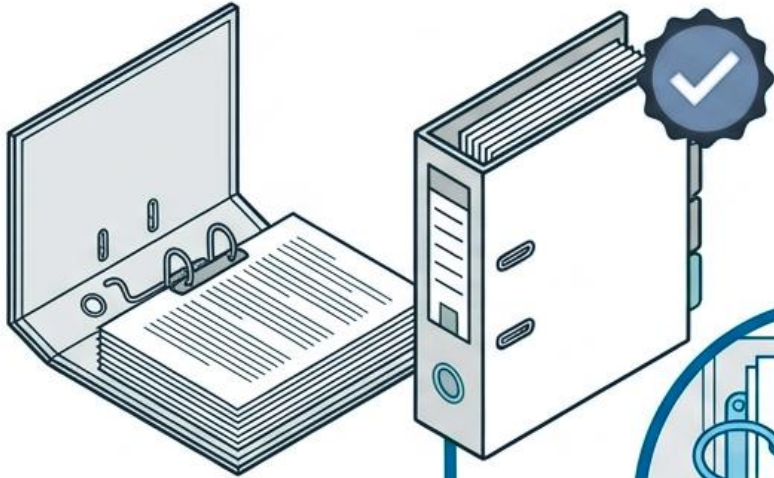

Mandatory for large dossiers.
Secures high-volume data reliably.

PLASTIC OR PAPER FOLDERS

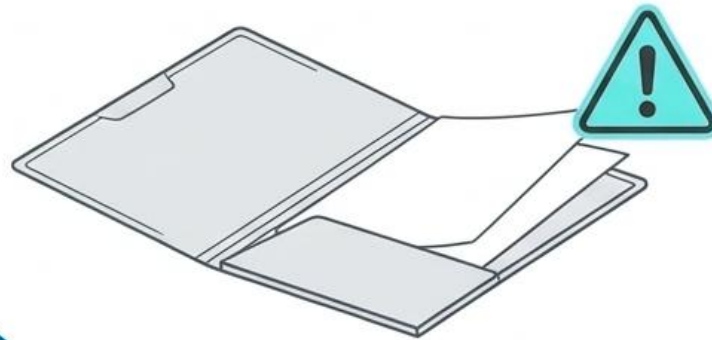

Restricted to smaller dossiers only.

RUBBER BANDS or
PAPER CLIPS

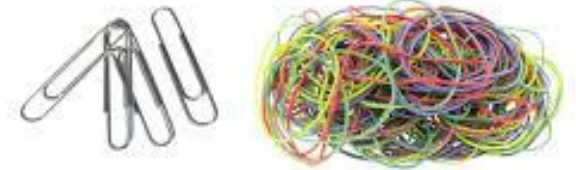

MARGIN RULE

Double-sided printing is accepted if legibility is unaffected. Margins must be wide enough to enable reading when tightly bound and placed on file.

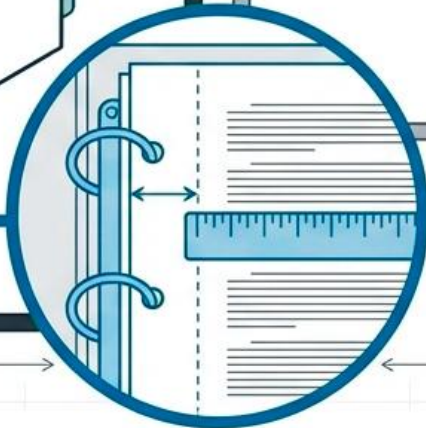

agriculture

Department:
Agriculture
REPUBLIC OF SOUTH AFRICA



The Translation Workflow

All applications and accompanying data submitted to the Registrar must be in English.

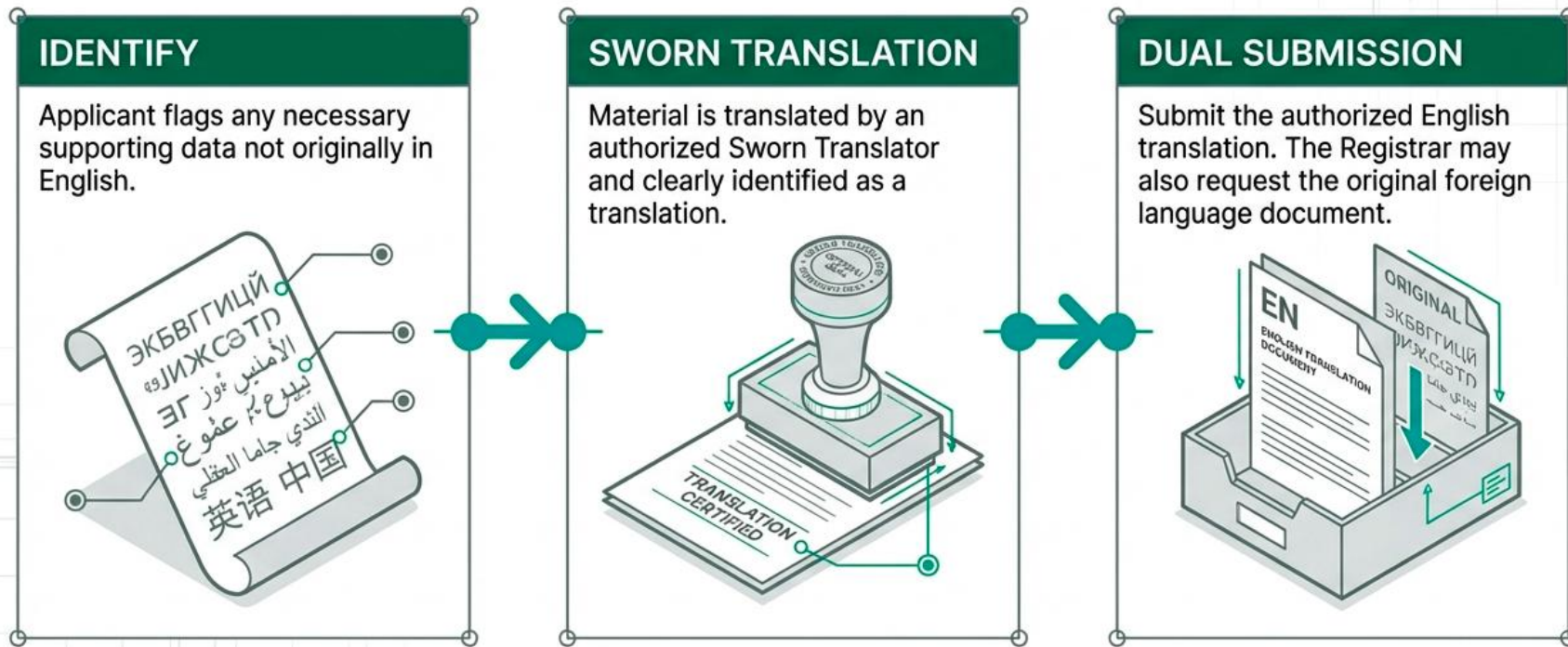

agriculture

Department:
Agriculture
REPUBLIC OF SOUTH AFRICA



The CBI Vault

DoA officials are required to protect specific Confidential Business Information (CBI) for an unlimited period.

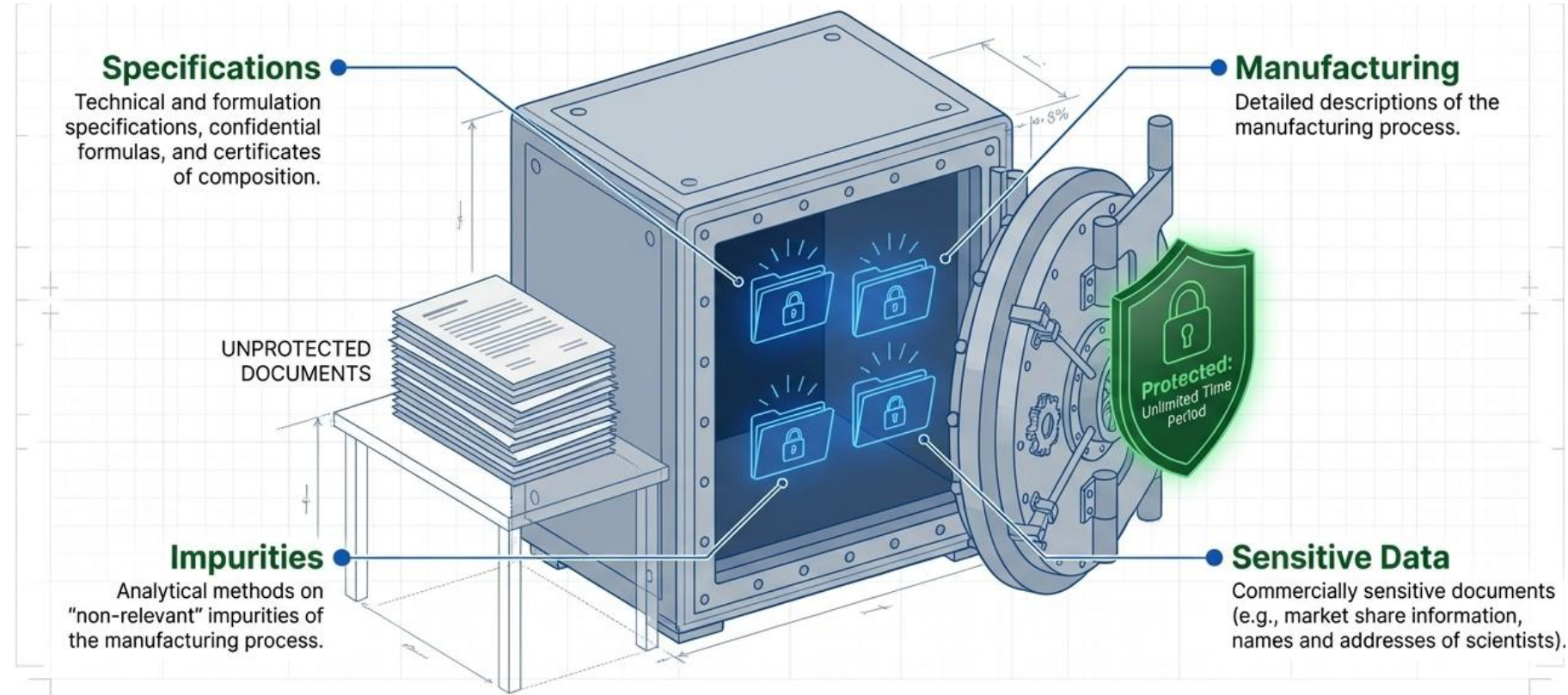

agriculture

Department:
Agriculture
REPUBLIC OF SOUTH AFRICA



Pre-Submission Checklist

Verify these structural requirements before submitting your dossier to the Registrar.

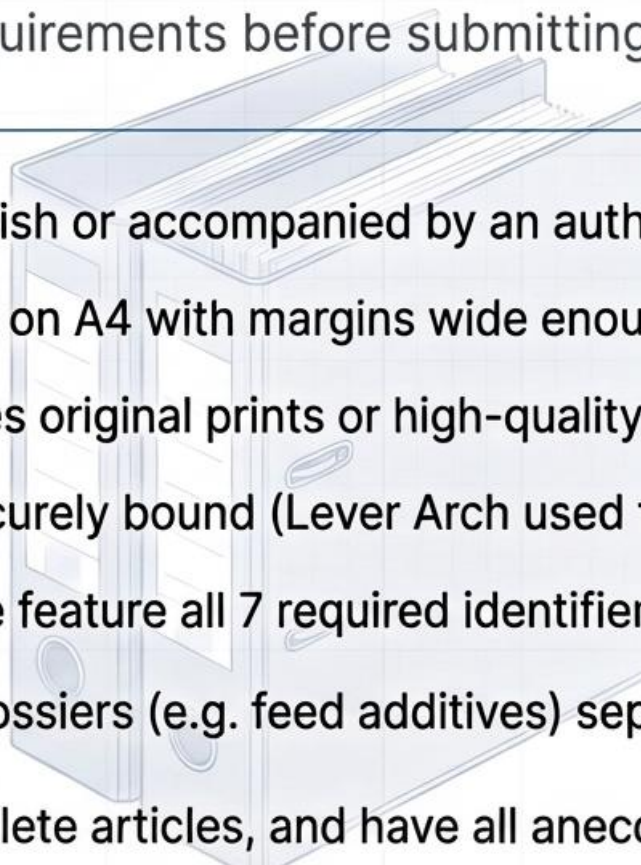
- 
- Is every word in English or accompanied by an authorized Sworn Translation?
 - Are all pages printed on A4 with margins wide enough for binding?
 - Are all graphic images original prints or high-quality replicable copies?
 - Is the application securely bound (Lever Arch used for massive files)?
 - Does the Cover Page feature all 7 required identifiers plus the Table of Contents?
 - Are more complex dossiers (e.g. feed additives) separated and indexed properly?
 - Are references complete articles, and have all anecdotal testimonials been removed?



agriculture

Department:
Agriculture
REPUBLIC OF SOUTH AFRICA



The Diagnostics: The Delay Ripple Effects

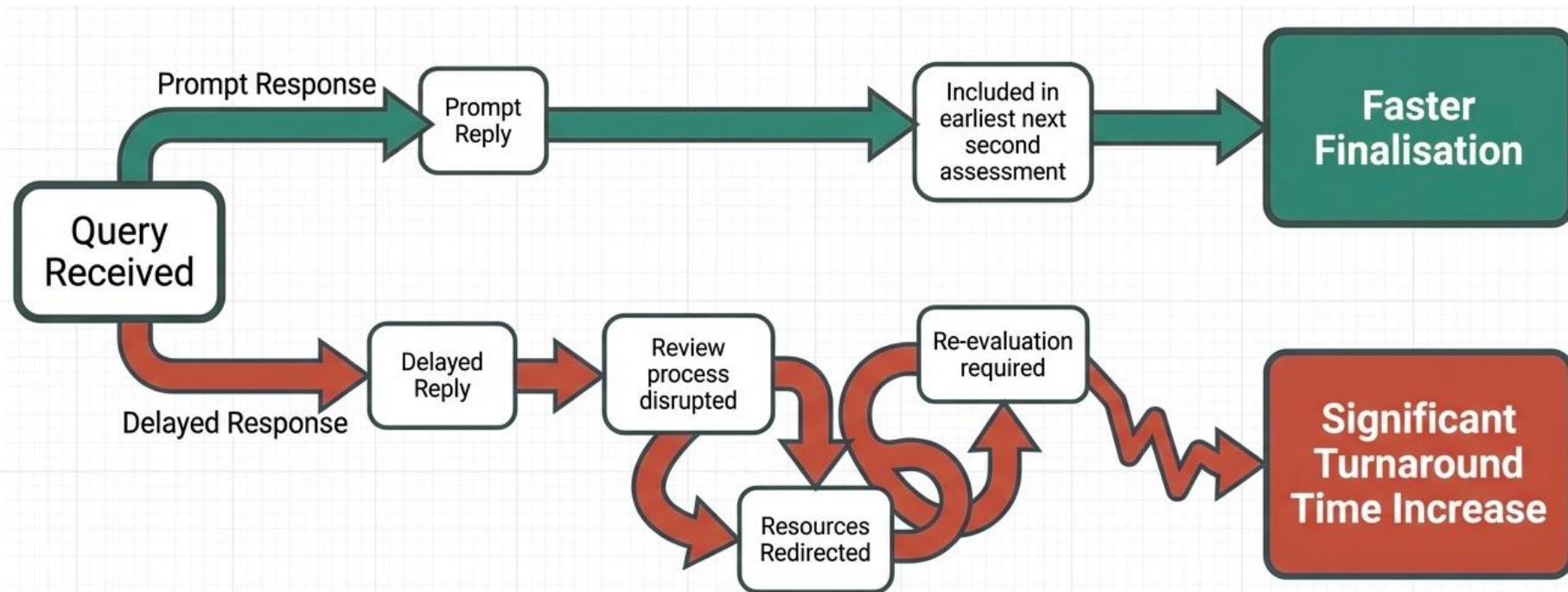

Takeaway: The process does not just pause; a delay forces the application to the back of the resource queue.







agriculture

Department:
Agriculture
REPUBLIC OF SOUTH AFRICA





The Complete Application Pre-Submission Checklist

Administrative

- 1. Cover Letter 
- 2. SRF_01 
- 3. PoP 
- 4. FF_01 (Duplicate) 
- 5. Contact Form 

Product

- 6. Label (Duplicate) 
- 7. PSS 
- 8. COA 

Science

- 9. Safety/Efficacy/Tox Data
- 10. Analytical Method

Manufacturing

- 11. Process Flow Diagram
- 12. Quality Management Cert

Regulatory

- 14. Free Sale Cert (Imports)
- 15. Local Legislation Proof (Imports)
- 16. Formulator Declaration

**Checklist Complete.
Ready for Submission.**

Accessing Farm Feed Resources and Forms

📍 Agriculture Place, 20 Steve Biko Street, Arcadia 📞 012 319 6000 ✉ queries@nda.gov.za 🕒 Mon - Friday: 8.00 am to 16.00 pm.



www.nda.gov.za

🔍 Search



🏠 HOME ABOUT US ▾ SERVICES CORE BUSINESS ▾ NEWSROOM ▾ CONTACT US TENDERS ▾ PARLIAMENTARY MATTERS PUBLICATIONS VACANCIES NOTICES

Agricultural Production Health & Food Safety, Natural Resources & Disaster Management	Inspection & Quarantine Services	Inspection Services
Food Security & Agrarian Reform	Plant Production & Health	Food Safety & Quality Assurance
Economic Development, Trade & Marketing	Animal Production & Health	Agriculture Inputs Control
Development Finance	Natural Resources Management	
	LUSM	
	Food Import Export Standards	



Stakeholder Engagement Workshop

Two Distinct Paths to Registration: A Practical Exercise



Path A: The Feed Additive

Product: PhytoBoost™ Oregano Essential Oil Feed Additive.

Profile: Requires rigorous substantiation of safety, efficacy, and toxicology to prove novel label claims.



Path B: The Premixture

Product: NutriGrow 0.5% Pig Grower Vitamin & Mineral Premix.

Profile: Evaluated primarily on detailed formulation reporting, constituent analysis, and manufacturing quality.



agriculture

Department:
Agriculture
REPUBLIC OF SOUTH AFRICA



Questions & Answer Session



agriculture

Department:
Agriculture
REPUBLIC OF SOUTH AFRICA



ACT 36 FARM FEED REGISTRATION WORKSHOP

THURSDAY, 26 MARCH 2026
IRENE COUNTRY CLUB, CENTURION

Practical Exercise: Preparing a Feed Additive
Registration Application

Dr. Cebisa Kumanda, Technical Advisor
DoA - Act 36 of 1947



ACT 36 FARM FEED REGISTRATION WORKSHOP

THURSDAY, 26 MARCH 2026
IRENE COUNTRY CLUB, CENTURION

Practical Exercise: Preparing a Premixture
Registration Application

Mr. David Vilakazi, Technical Advisor
DoA - Act 36 of 1947

